

Biomedical Data Science (GersteinLab.org/courses/452)

Network Topology – Generation Models (23m10c)

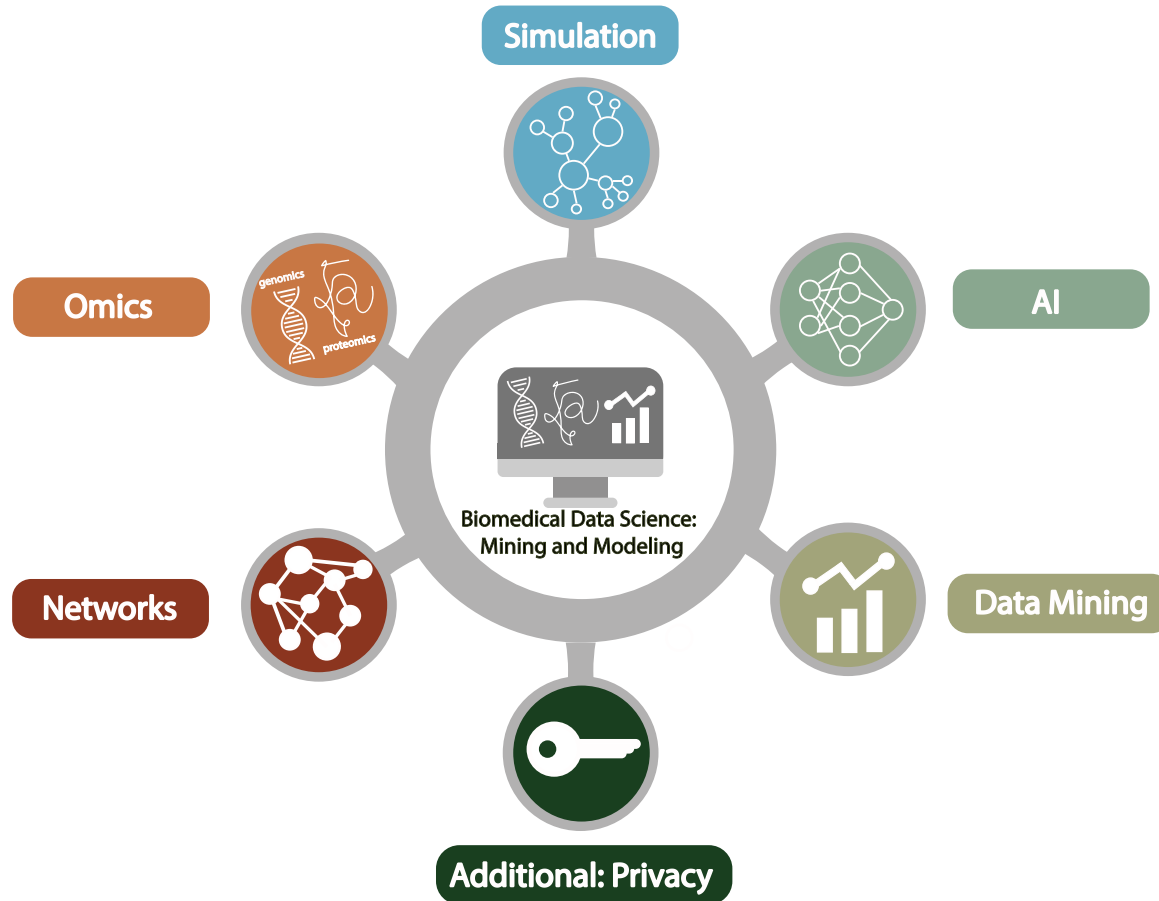

Network Topology

**Simple Mathematical Models
for Interpreting Complex
Topology: ER Model & Small
World Networks**

Models for networks of complex topology

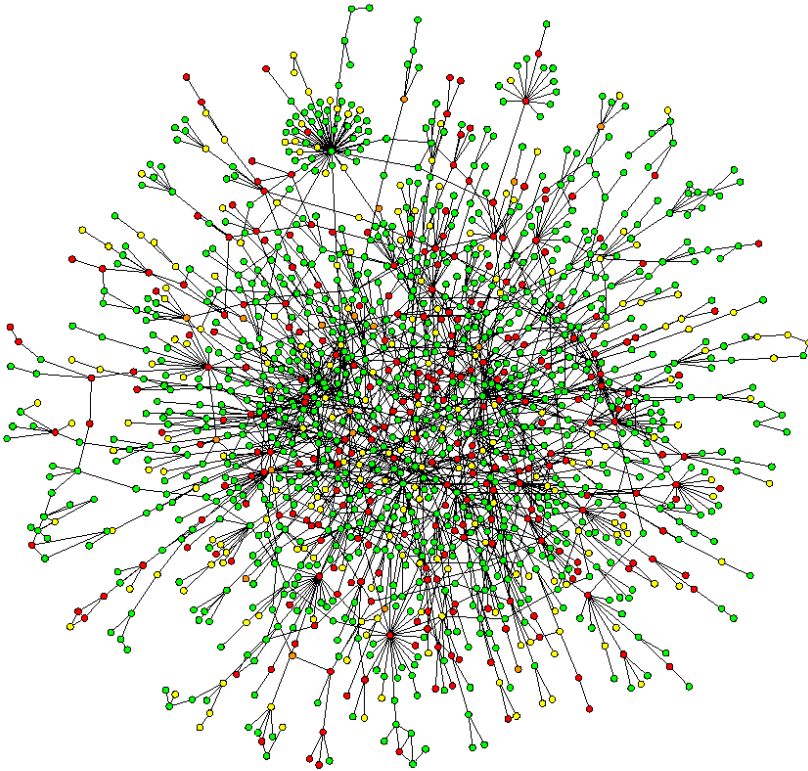

- Erdos-Renyi (1960)
- Watts-Strogatz (1998)
- Barabasi-Albert (1999)

**A Barabási & R Albert
"Emergence of scaling in
random networks,"
Science 286, 509-512 (1999).**

The Erdős-Rényi [ER] model (1960)

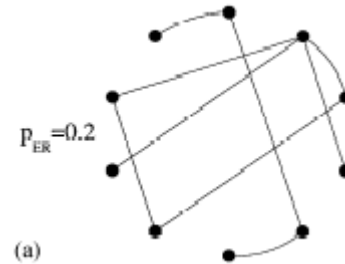
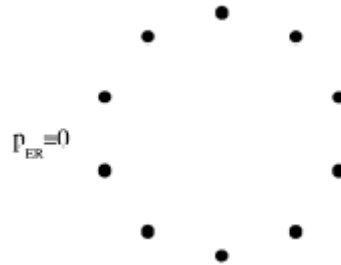

- Start with N vertices and no edges
- Connect each pair of vertices with probability P_{ER}

Important result: many properties in these graphs appear quite suddenly, at a threshold value of $P_{ER}(N)$

- If $P_{ER} \sim c/N$ with $c < 1$, then almost all vertices belong to isolated trees
- Cycles of all orders appear at $P_{ER} \sim 1/N$

The Watts-Strogatz [WS] model (1998)

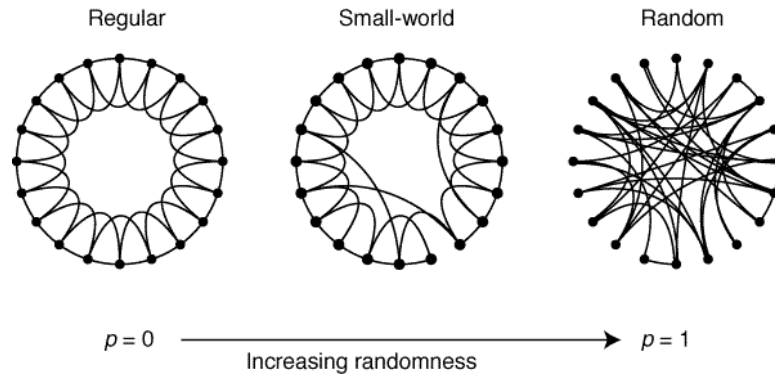

- Start with a regular network with N vertices
- Rewire each edge with probability p

For $p=0$ (Regular Networks):

- high clustering coefficient
- high characteristic path length

For $p=1$ (Random Networks):

- low clustering coefficient
- low characteristic path length

QUESTION: What happens for intermediate values of p ?

1) There is a broad interval of p for which L is small but C remains large

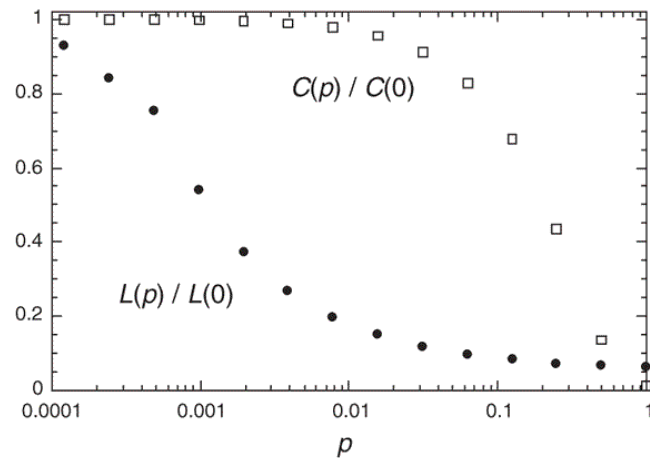

2) Small world networks are common :

Table 1 Empirical examples of small-world networks

	L_{actual}	L_{random}	C_{actual}	C_{random}
Film actors	3.65	2.99	0.79	0.00027
Power grid	18.7	12.4	0.080	0.005
<i>C. elegans</i>	2.65	2.25	0.28	0.05

Small world network

- A simple connected graph G exhibiting two properties:
 - **Large Clustering Coefficient:** Each vertex of G is linked to a relatively well-connected set of neighboring vertices, resulting in a large value for the clustering coefficient $C(G)$;
 - **Small Characteristic Path Length:** The presence of short-cut connections between some vertices results in a small characteristic path length $L(G)$.

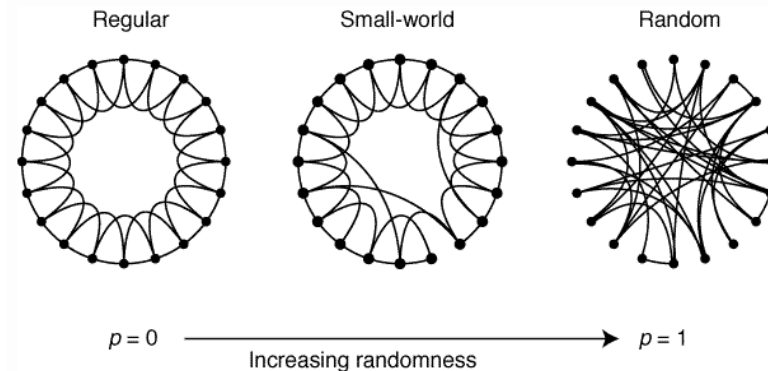

- local connectivity and global reach

Network Topology

**Simple Mathematical Models
for Interpreting Complex
Topology: BA Model & Scale
Free Networks**

Random v Scale-free Networks

RANDOM NETWORKS, which resemble the U.S. highway system (*simplified in left map*), consist of nodes with randomly placed connections. In such systems, a plot of the distribution of node linkages will follow a bell-shaped curve (*left graph*), with most nodes having approximately the same number of links.

In contrast, scale-free networks, which resemble the U.S. airline system (*simplified in right map*), contain hubs (red)—

nodes with a very high number of links. In such networks, the distribution of node linkages follows a power law (*center graph*) in that most nodes have just a few connections and some have a tremendous number of links. In that sense, the system has no “scale.” The defining characteristic of such networks is that the distribution of links, if plotted on a double-logarithmic scale (*right graph*), results in a straight line.

Random Network

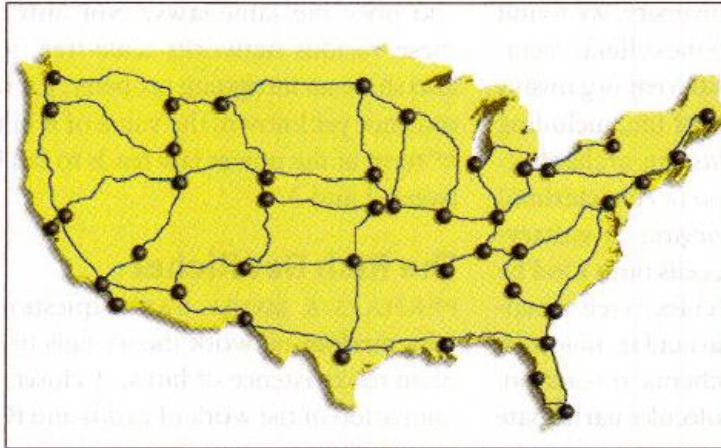

Scale-Free Network

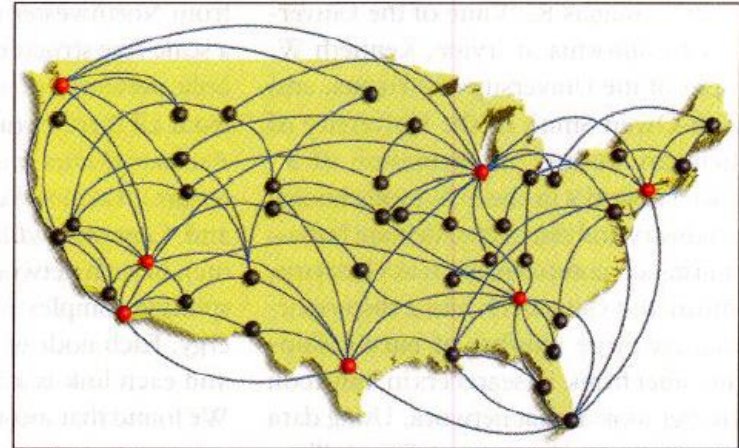

Bell Curve Distribution of Node Linkages

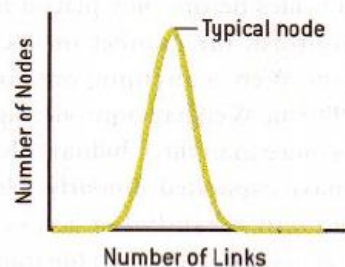

Power Law Distribution of Node Linkages

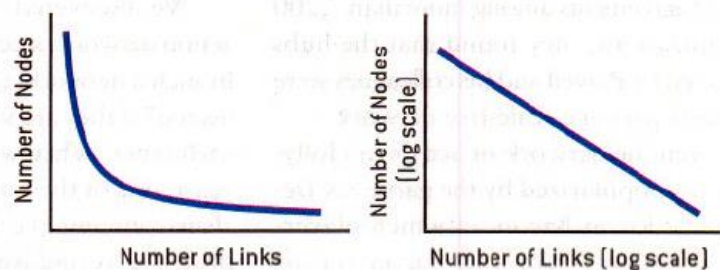

The Barabási-Albert [BA] model (1999)

Look at the distribution of degrees

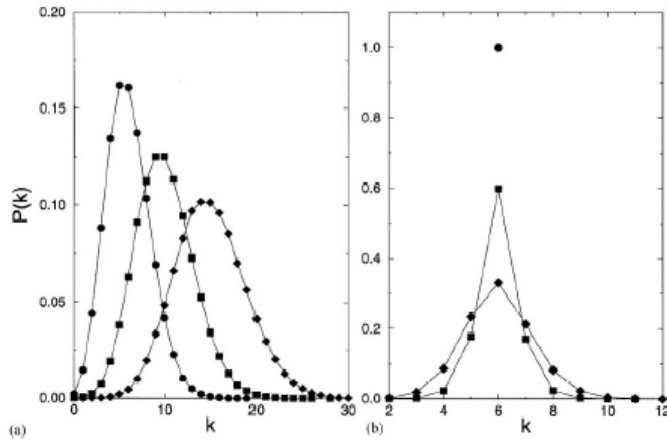

ER Model

WS Model

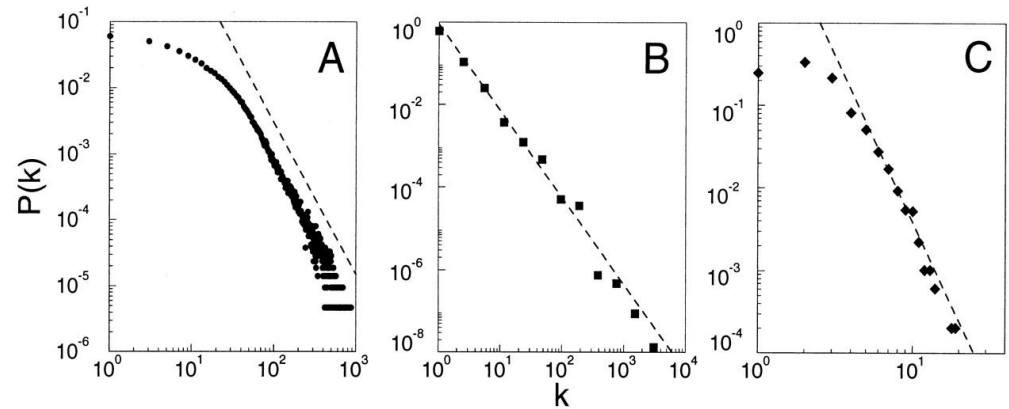

actors

power grid

www

The probability of finding a highly connected node decreases exponentially with k

$$P(K) \sim K^{-\gamma}$$

- two problems with the previous models:
 1. N does not vary
 2. the probability that two vertices are connected is uniform

- **GROWTH:** starting with a small number of vertices m_0 at every timestep add a new vertex with $m \leq m_0$

- **PREFERENTIAL ATTACHMENT:** the probability Π that a new vertex will be connected to vertex i depends on the connectivity of that vertex:

$$\Pi(k_i) = \frac{k_i}{\sum_j k_j}$$

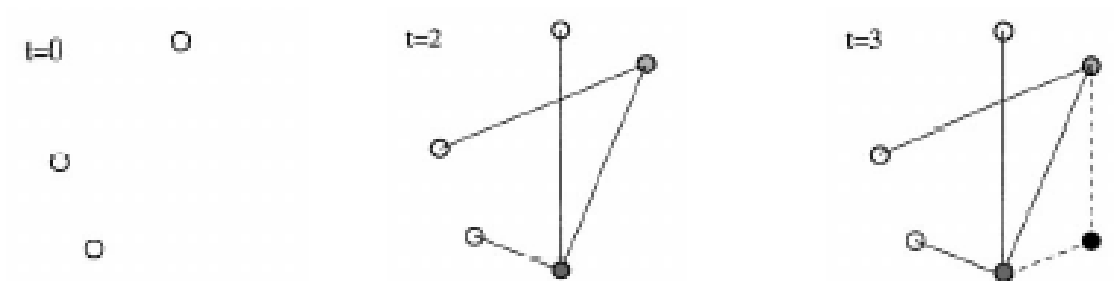

Birth of Scale-Free Network

A SCALE-FREE NETWORK grows incrementally from two to 11 nodes in this example. When deciding where to establish a link, a new node [*green*] prefers to attach to an existing node [*red*] that already has many other connections. These two basic mechanisms—growth and preferential attachment—will eventually lead to the system's being dominated by hubs, nodes having an enormous number of links.

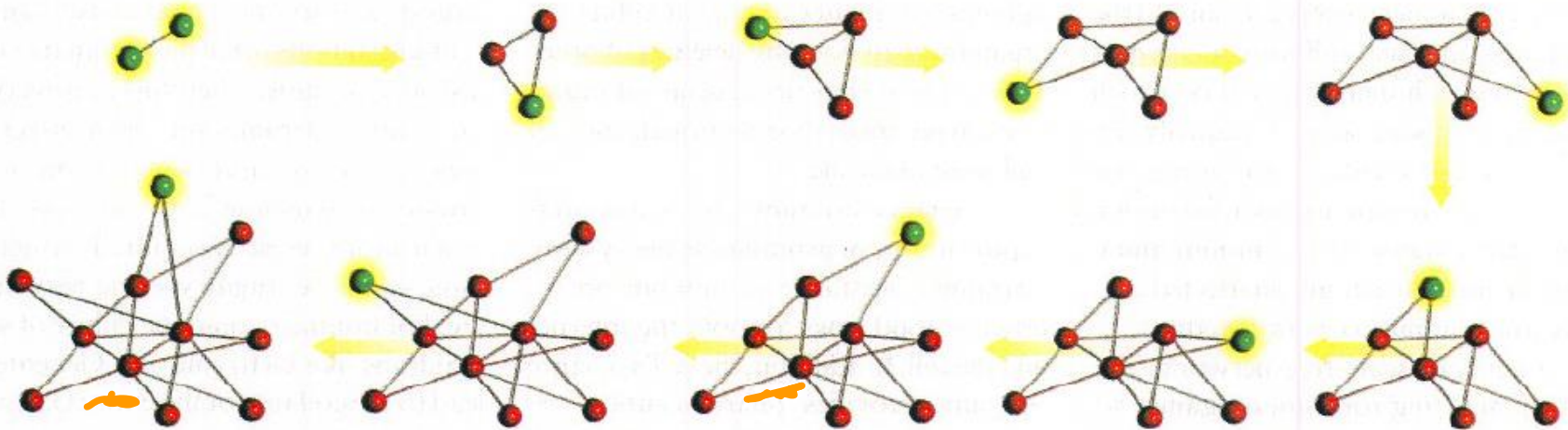

SCALE FREENESS GENERALLY EVOLVES THROUGH PREFERENTIAL ATTACHMENT (THE RICH GET RICHER)

The Duplication Mutation Model

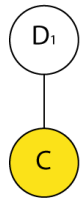

Gene duplication

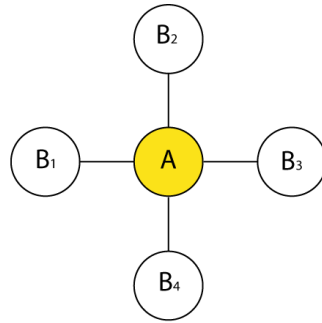

The interaction partners of A are more likely to be duplicated

Description

- Theoretical work shows that a mechanism of preferential attachment leads to a scale-free topology (“The rich get richer”)
- In interaction network, gene duplication followed by mutation of the duplicated gene is generally thought to lead to preferential attachment
- Simple reasoning: The partners of a hub are more likely to be duplicated than the partners of a non-hub

SCALE FREENESS GENERALLY EVOLVES THROUGH PREFERENTIAL ATTACHMENT (THE RICH GET RICHER)

The Duplication Mutation Model

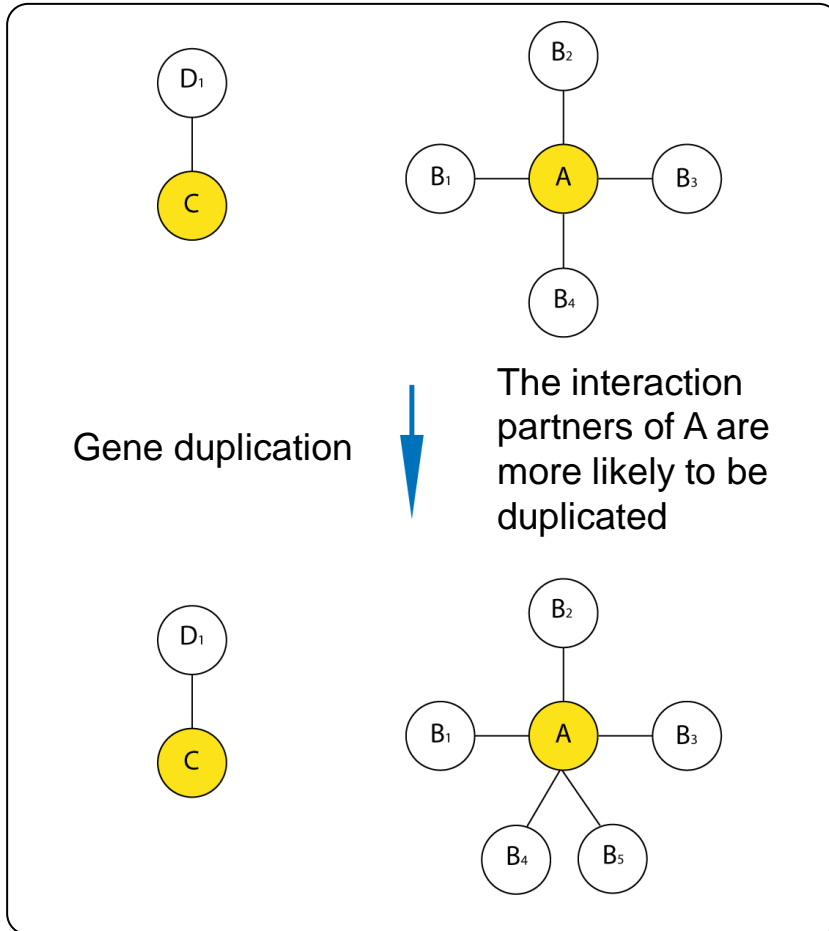

Description

- Theoretical work shows that a mechanism of preferential attachment leads to a scale-free topology (“The rich get richer”)
- In interaction network, gene duplication followed by mutation of the duplicated gene is generally thought to lead to preferential attachment
- Simple reasoning: The partners of a hub are more likely to be duplicated than the partners of a non-hub